

## POWER 1AC 24-3 ECO Quick Installation Guide

Manufacturer:  
SALZ Automation GmbH,  
Bad Salzflun, Germany



### 1. Overview

POWER 1AC 24-3 ECO is a 1 $\phi$  power supply with a 24V DC output and 3.2A max. output current (75W).

### 2. Package Checklist

- POWER 1AC 24-3 ECO x 1

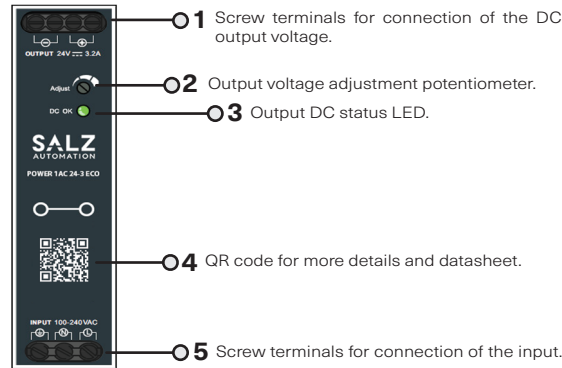

### 3. Mounting and Dismounting to DIN-Rail

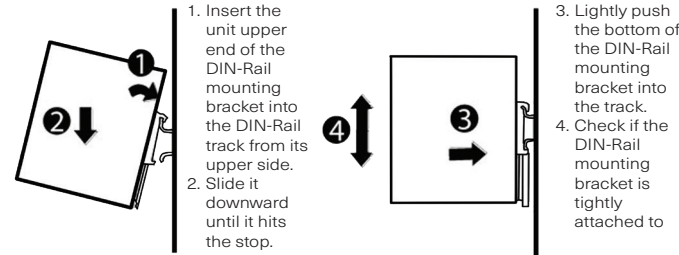

- Mount the unit on the DIN-Rail rack vertically to keep the input terminals at the bottom and output on the top. Other positions are not allowed.
- Disconnect AC power before installing wiring.

### 4. Wiring

**Electrical equipment should be installed, operated, serviced, and maintained only by qualified personnel.**

- WARNING**  
UNINTENDED EQUIPMENT OPERATION
- Use appropriate safety interlocks where personnel and/or equipment hazards exist.
  - Install and operate this equipment in an enclosure appropriately rated for its intended environment and secured by a keyed or tooling locking mechanism.
  - Power line and output circuits must be wired and fused in compliance with local and national regulatory requirements for the rated current and voltage of the equipment.
  - Do not disassemble, repair, or modify this equipment.
  - Do not connect any wiring to reserved, unused connections, or to connections designated as No Connection (N.C.).
  - Adhere to the proper mounting and wiring instructions contained herein.
- DANGER**  
HAZARD OF ELECTRIC SHOCK, EXPLOSION, OR ARC FLASH
- Disconnect all power from all equipment including connected devices before removing any covers or doors, or installing or removing any accessories, hardware, cables, or wires except under the specific conditions specified.
  - Wait 5 minutes to allow the internal capacitors to discharge.
  - Always use a properly rated voltage sensing device to confirm the power is off where and when indicated.
  - Replace and secure all covers, accessories, hardware, cables, and wires, and confirm that a proper ground connection exists before applying power to the unit.
  - Use only the specified voltage when operating this equipment and any associated products.
- CAUTION**  
HAZARD OF BURNS
- Avoid unprotected contact with hot surfaces.
- EQUIPMENT OPERATION HAZARD**
- Use the equipment in a controlled environment as specified in documentation.
  - Do not exceed the maximum output power or output current rating when adjusting the output voltage.

### Wiring AC Power Inputs and DC Outputs

- AC Power Input Wiring: For AC (100—240V) power input wiring, please connect to L (Live line), N (Null Line) and GND (Ground) terminals.
- DC Power Output Wiring: Insert the Negative / Positive DC wires into the PWR terminals. Tighten the screws to prevent the wires from loosening.
- Recommended wire stripping length: 6.5mm(0.255")
- Tighten the screws to prevent the wires from loosening.

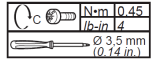

### Technical Data

		Rated Voltage/Current	24V/ 3.2A
Output	Current Range	0-3.2 A	
	Rated Power	75W	
	Ripple	150mVp-p	
	Voltage Regulation	±1%	
	Adjustable output voltage range	21.6~27.6V	
Input	Voltage Range	100 ... 240 Vac 140 ... 340 Vdc	
	Frequency Range	50-60 Hz	
Protection Function	Short Circuit and Over-current protection	Self-recovery	

### 5. LED Indicators

Function	Status	Description
DC OK	ON (Green)	Power on, ready to supply DC 24V.
	OFF	Power off or malfunction.

### 6. Environmental Requirements

Surrounding Air Temperature	115 Vac / 162 Vdc: -10 °C ... 40 °C 230 Vac / 325 Vdc: -10 °C ... 50 °C
Installation Altitude	≤2000 m/ ≤6561 ft.
Pollution Degree	2
Relative humidity at +25 °C, no condensation	5 % ... 95 %
Overvoltage Category	OVC II
Degree of protection	IP20, IEC 60529
Max. operating temperature for cables	75 °C

### 7. Derating Curve

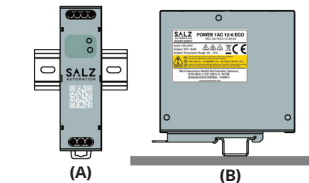

- θ<sup>0</sup>: Surrounding air temperature  
% : Percentage of maximum load
- 1 : ≤ 2000 m (6561 ft), ≈ 230 V / ≈ 325 V  
2 : ≤ 2000 m (6561 ft), ≈ 115 V / ≈ 162 V  
4 : ≤ 5000 m (16404 ft), ≈ 230 V / ≈ 325 V (IEC/UL 62368-1)  
5 : ≤ 5000 m (16404 ft), ≈ 115 V / ≈ 162 V (IEC/UL 62368-1)

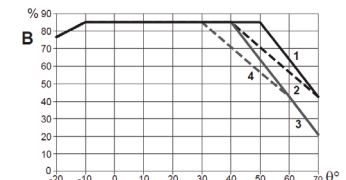
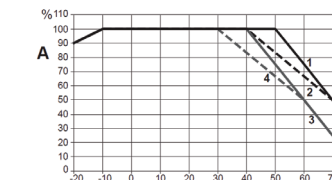

If the equipment is used in an unspecified or unauthorized manner, the protection provided by the equipment may be impaired.

## POWER 1AC 24-3 ECO 用户手册

制造商：  
SALZ Automation GmbH,  
Bad Salzflen, Germany



### 1. 概要

POWER 1AC 24-3 ECO是一台75W单相电源，其额定输出电压为24VDC，最大输出电流为3.2A。

### 2. 面板说明

- POWER 1AC 24-3 ECO x 1



### 3. DIN导轨的安装与拆卸

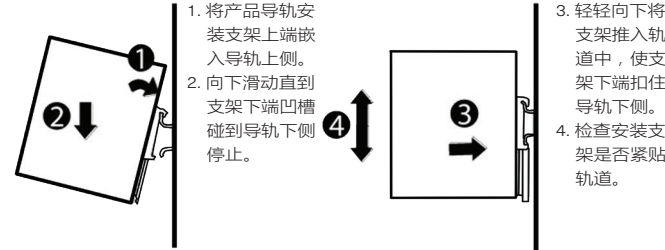

- 产品必须垂直正向安装在导轨上，即输出端在上，输入端在下。不能使用其他位置安装。
- 产品必须在断电状态下进行安装与接线。

### 4. 接线

电气设备的安装、操作、维修和维护工作必须由专业人员执行。



#### 警告

意外的设备操作

- 请在存在人身或设备危险的位置使用合适的安全联锁。
- 在符合本设备运行时所处环境等级且通过钥匙锁闭装置来锁闭的机箱种安装和操作本设备。
- 必须遵从当地和国家法规种对特定设备额定电流和电压的规定，对电线和输出电路进行布线，安装熔断器。
- 请勿拆解、修理或改装本设备。
- 请勿将任何线路连接至已保留的未用连接点，或指示为“无连接(N.C.)”的连接点。
- 请遵守此处所述的正确安装和接线说明。



#### 危险

存在电击、爆炸或电弧闪烁危险

- 在卸除任何护盖，或安装或卸除任何附件、硬件、电缆或导线之前，先断开所有设备的电源连接(包括已连接设备)，此设备的相应硬件指南中另有指定的特定情况除外。
- 请等待5分钟，以使内部电容器放电。
- 在有需要的地方和时候，无比使用合适额定电压的设备来检测是否断电。
- 更换并紧固所有护盖、附件、硬件、电缆与电线。并确认接地连接正确后再对设备通电。
- 在操作本设备及相关产品时，必须使用指定电压。



#### 注意事项

灼伤危险

- 请避免无保护接触热表面。



设备运行危险

- 请按照产品资料中规定的温度和湿度，在受控环境中使用设备。
- 调整输出电压时，不要超过最大输出功率或输出电流额定值。

### 交流电源输入端与直流输出端接线

- 交流电源输入端接线：将交流(100-240V)电源输入的导线，分别连接至对应的L(火线)、N(零线)和GND(接地)端。
- 直流电源输出端接线：将负/正直流输出的导线，分别连接至对应的-/+端。
- 建议导线剥线长度：6.5mm。
- 拧紧所有螺钉，以防止导线松动。

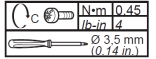

### 技术参数

输出	额定电压/电流	24V/ 3.2A
	电流范围	0-3.2 A
	额定功率	75W
	纹波	150mVp-p
	输出电压波动	±1%
	输出电压可调范围	21.6~27.6V
输入	电压范围	100 ... 240 Vac 140 ... 340 Vdc
	频率范围	50-60 Hz
保护功能	带短路与过流保护	断电自动复位

### 5. LED指示灯

功能	状态	说明
DC OK	ON (绿色)	通电状态，可供24VDC
	OFF	断电或故障

### 6. 环境要求

环境空气温度	115 Vac / 162 Vdc: -10 °C ... 40 °C 230 Vac / 325 Vdc: -10 °C ... 50 °C
安装海拔高度	≤2000 m/ ≤6561 ft.
污染等级	2
相对湿度(25 °C，无凝露)	5 % ... 95 %
过电压类别	OVC II
防护等级	IP20, IEC 60529
导线最高工作温度	75 °C

### 7. 降容曲线

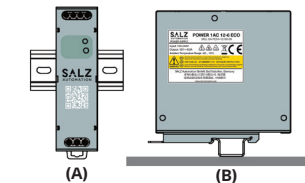

- θ<sub>a</sub>: 环境空气温度  
%: 最大负载百分比
- ▲ ≤ 2000 m (6561 ft), ≈ 230 V / ∓ 325 V
  - ▲ ≤ 2000 m (6561 ft), ≈ 115 V / ∓ 162 V
  - ▲ ≤ 5000 m (16404 ft), ≈ 230 V / ∓ 325 V (IEC/UL 62368-1)
  - ▲ ≤ 5000 m (16404 ft), ≈ 115 V / ∓ 162 V (IEC/UL 62368-1)

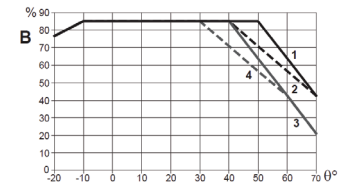
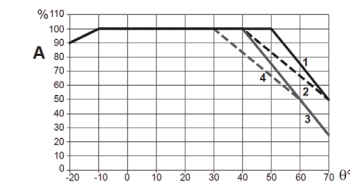

如果以未规定的或未经授权的方式使用该设备，则各种保护功能可能失效。